

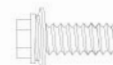













A		1PCS	I	 5/16" * 3/4"	3PCS
B		1PCS	J	 1/4" * 46mm	6PCS
C		1PCS	K	 1/4" * 1"	4PCS
D		1SET	L	 M5	1PCS
E		1PCS	*The below Add-On can be purchased separately Head Rest:		
F		1PCS	M		1PCS
G		5PCS	O		1PCS
H	 M4	1PCS	P	 3/16" * 14mm	2PCS



**Lida Chair**  
&  
Add-On: Lida Head Rest  
Assembly Instructions

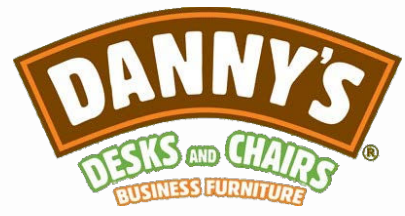
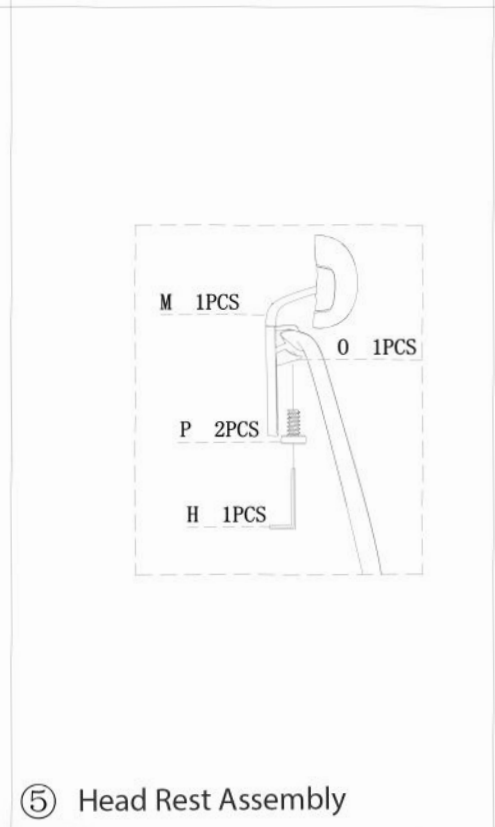
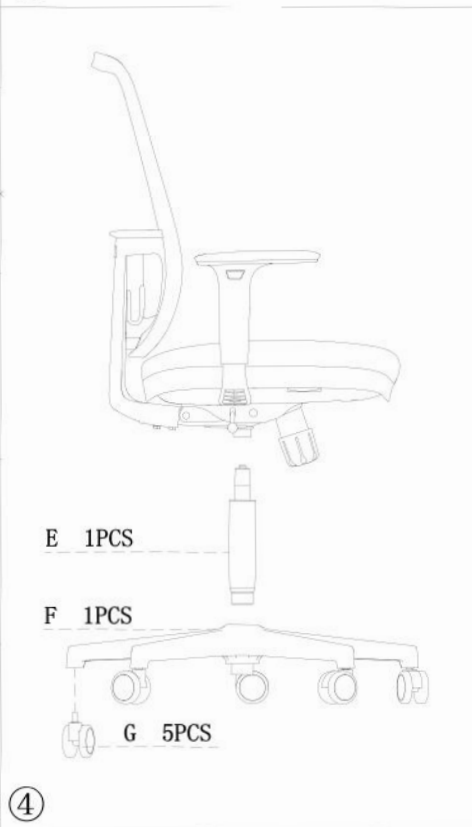
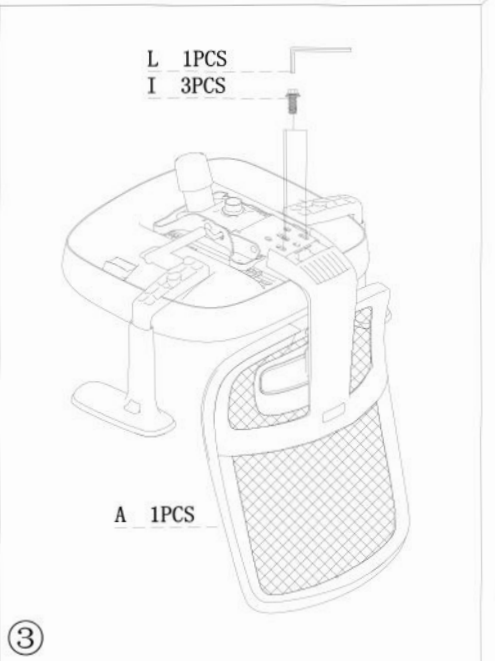
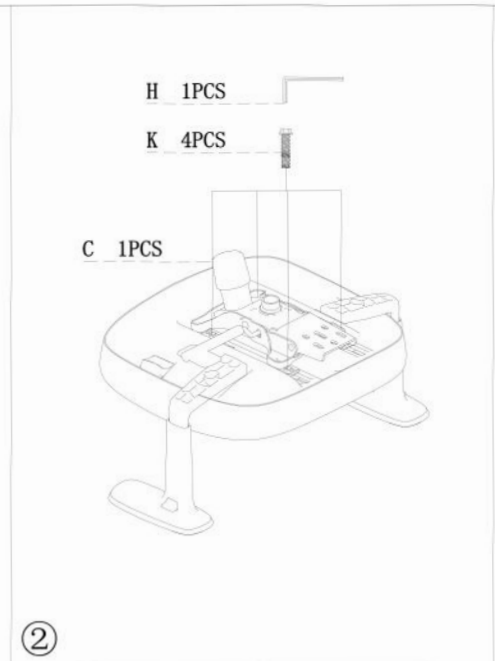
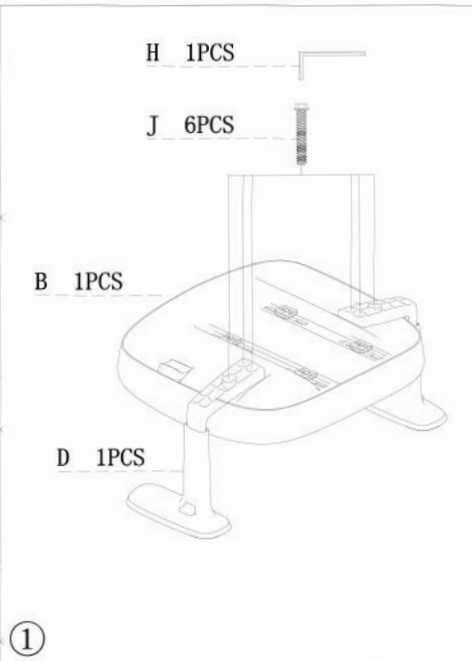
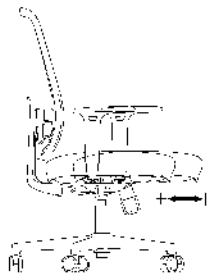
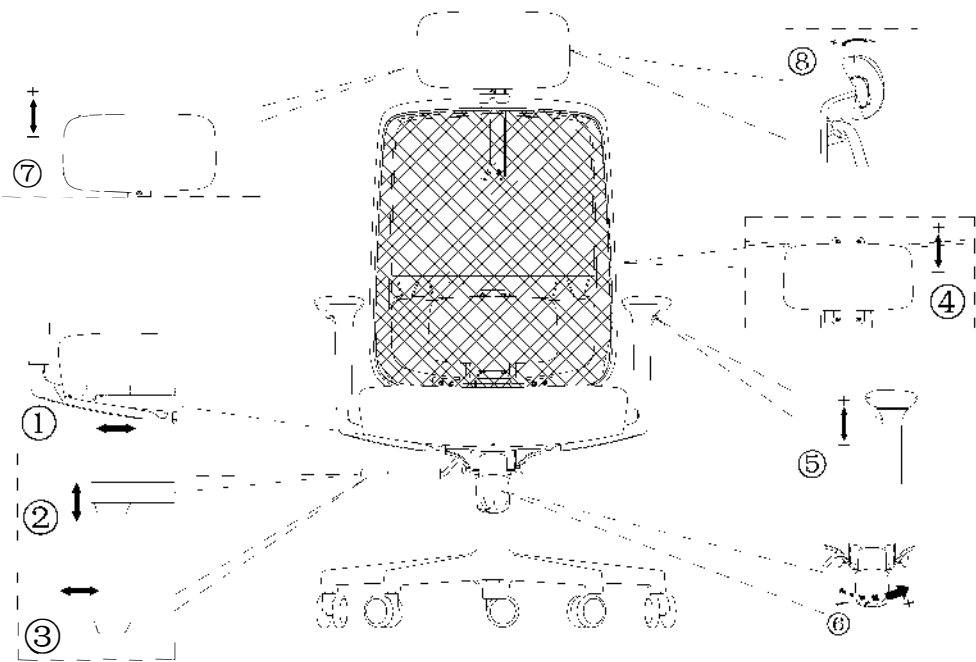

①

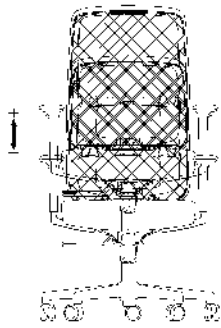

②

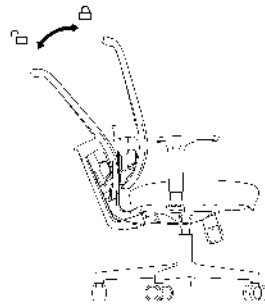

③

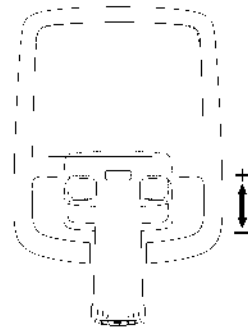

④

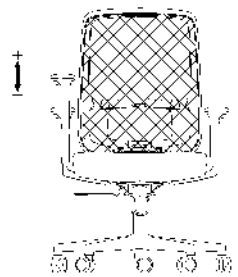

⑤

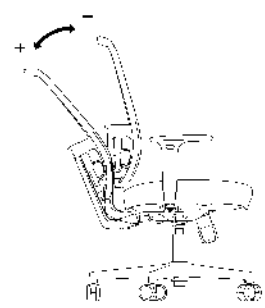

⑥

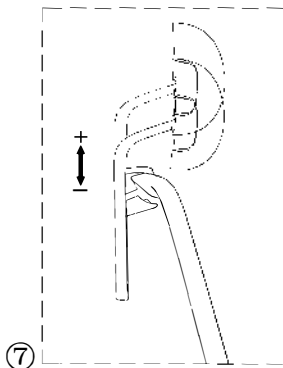

⑦

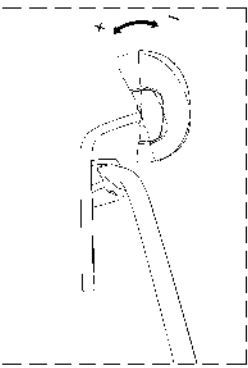

⑧

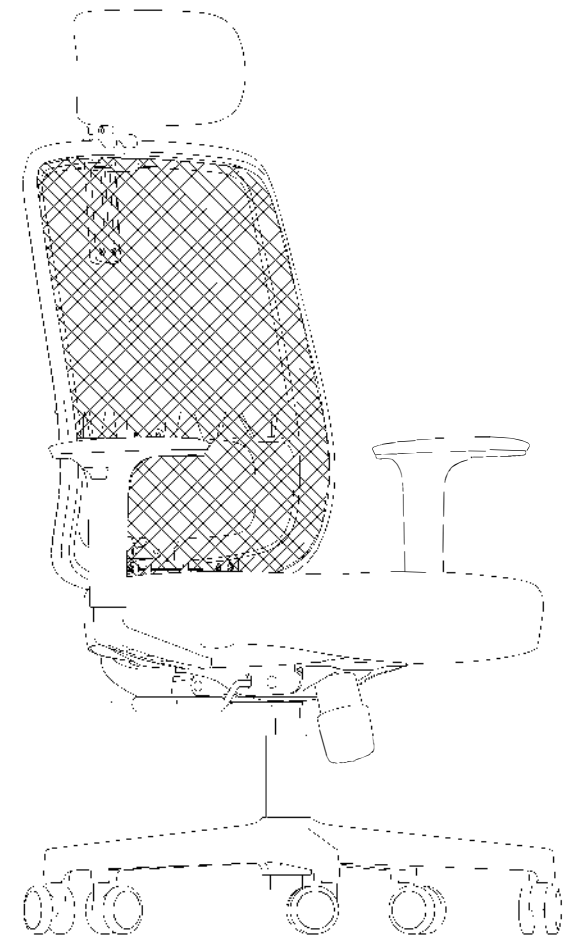

# Lida Chair

&  
Add-On: Lida Head Rest User  
Guide