

# POD-4 BEAM

## » ASSEMBLY INSTRUCTIONS

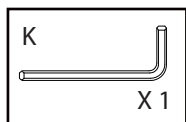

### » PARTS

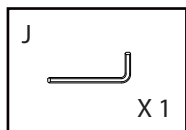
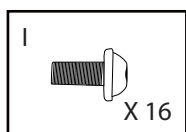
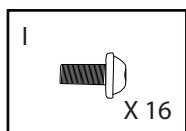
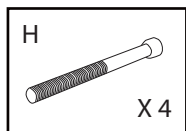
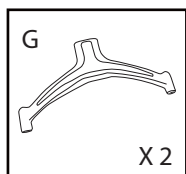
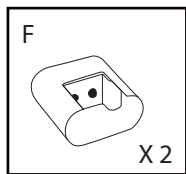
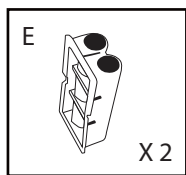
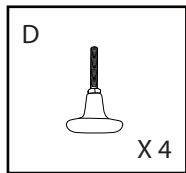
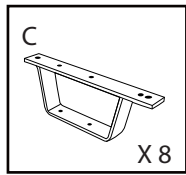
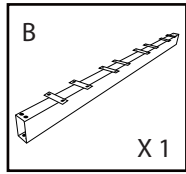
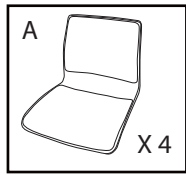

### » STEPS

#### » STEP 1

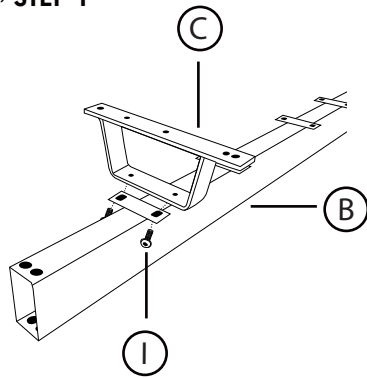

#### » STEP 2

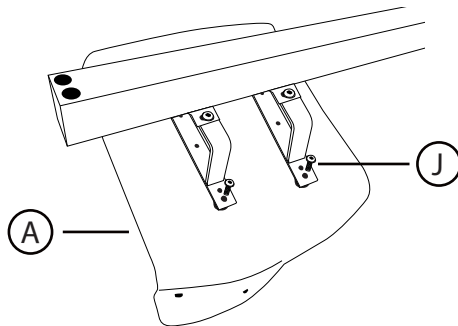

#### » STEP 3

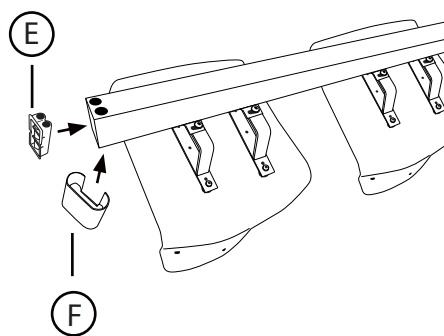

#### » STEP 4

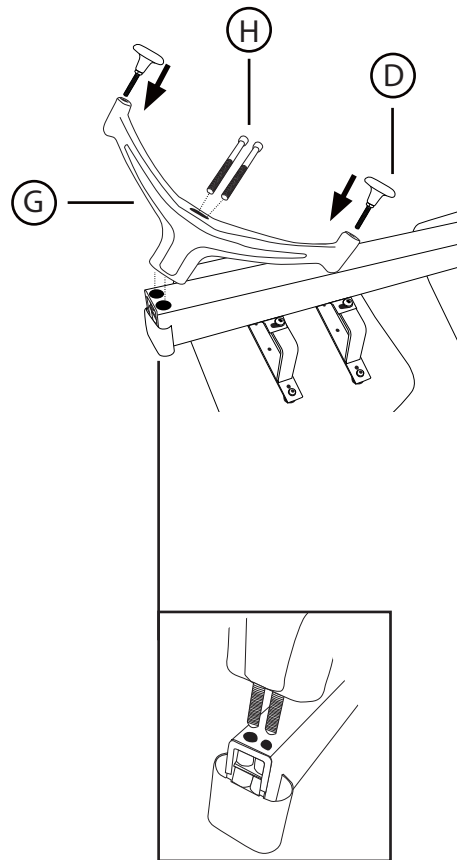

#### » STEP 5

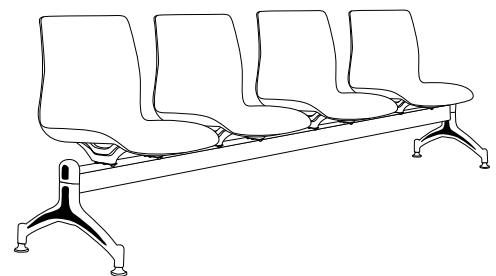

### PREVENTIVE MAINTENANCE AND WARNING

- » **USE** this product only for seating one person at a time.
- » **DO NOT** use this chair as a step stool/ladder.
- » **DO NOT** sit on any part of the chair except the seat.
- » **DO NOT** use chair on uneven floor surfaces.
- » **DO NOT** use chair unless all bolts, screws are tight.  
At least every 6 months check all bolts, screws to be sure they are tight.

IF ANY PARTS ARE MISSING, BROKEN, DAMAGED OR WORN, STOP USE OF THE PRODUCT UNTIL REPAIRS ARE MADE USING FACTORY AUTHORIZED PARTS.

FAILURE TO FOLLOW THESE WARNINGS COULD RESULT IN SERIOUS INJURY.