

WON-BC18 900*330*1800

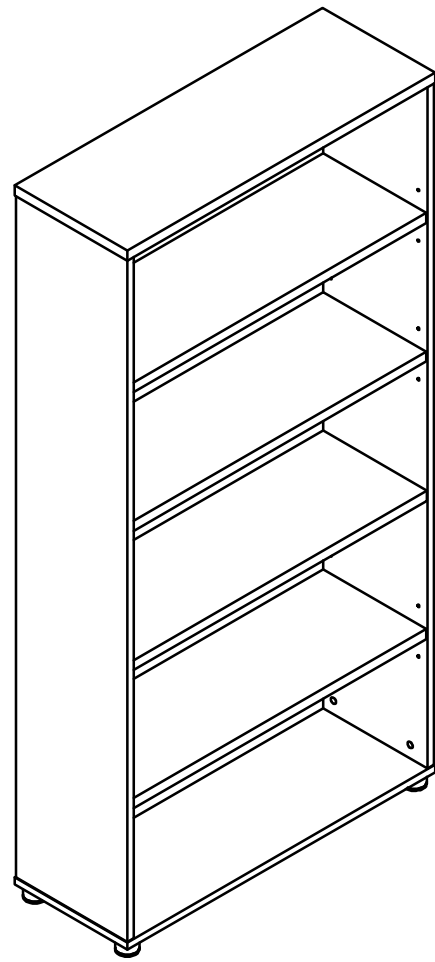

STEP 1:

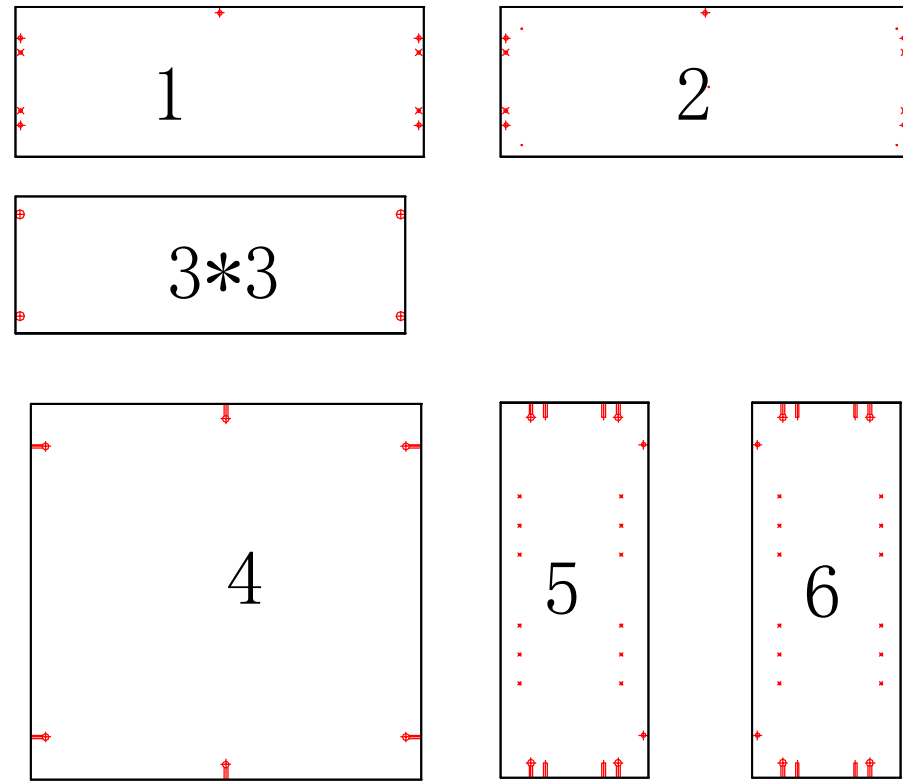

STEP 2:

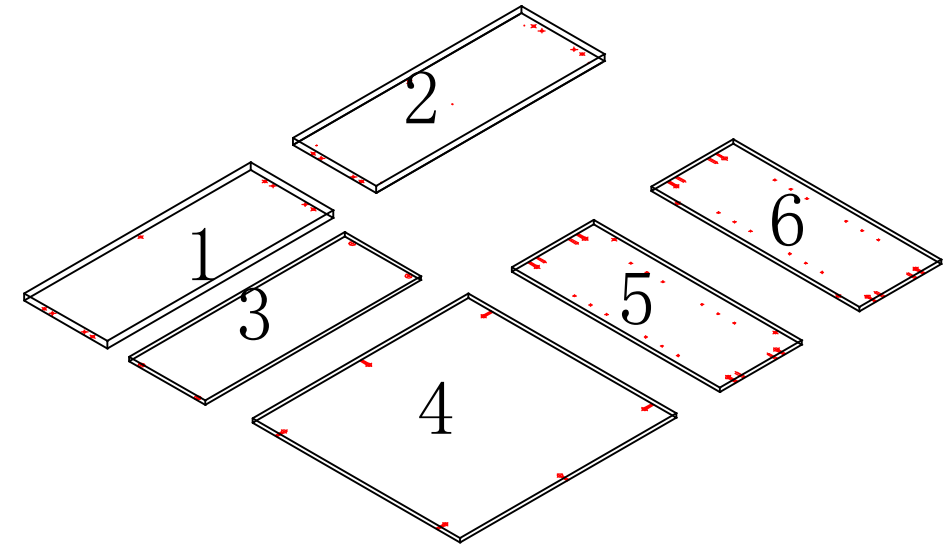

STEP 3:

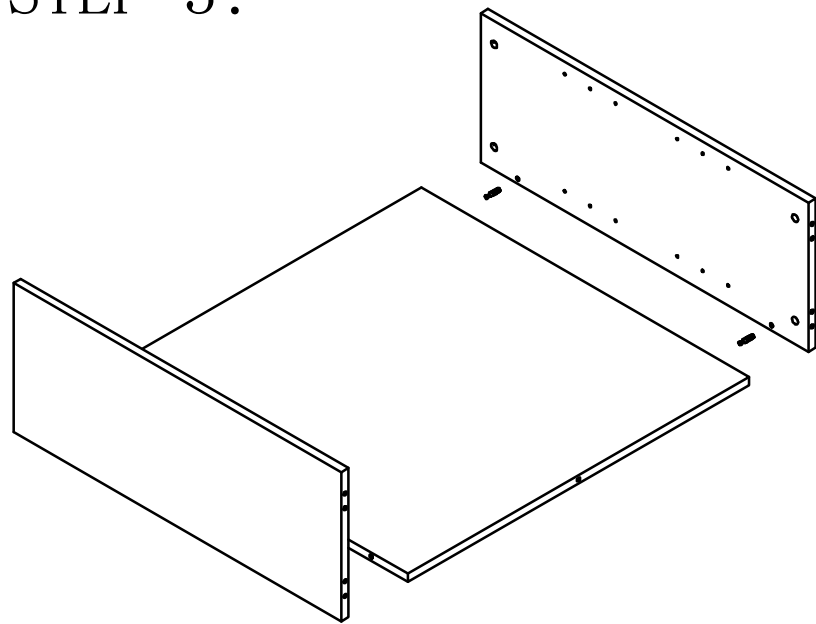

STEP 4:

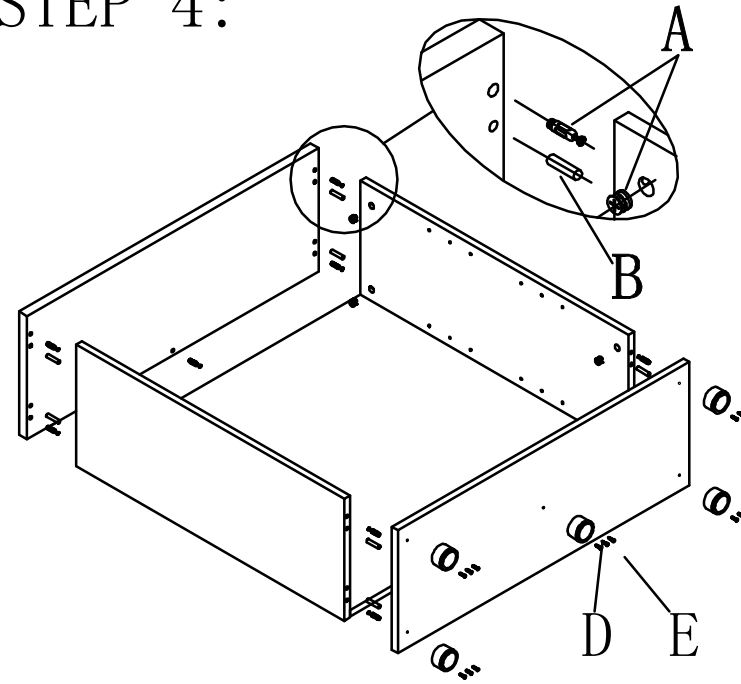

STEP 5:

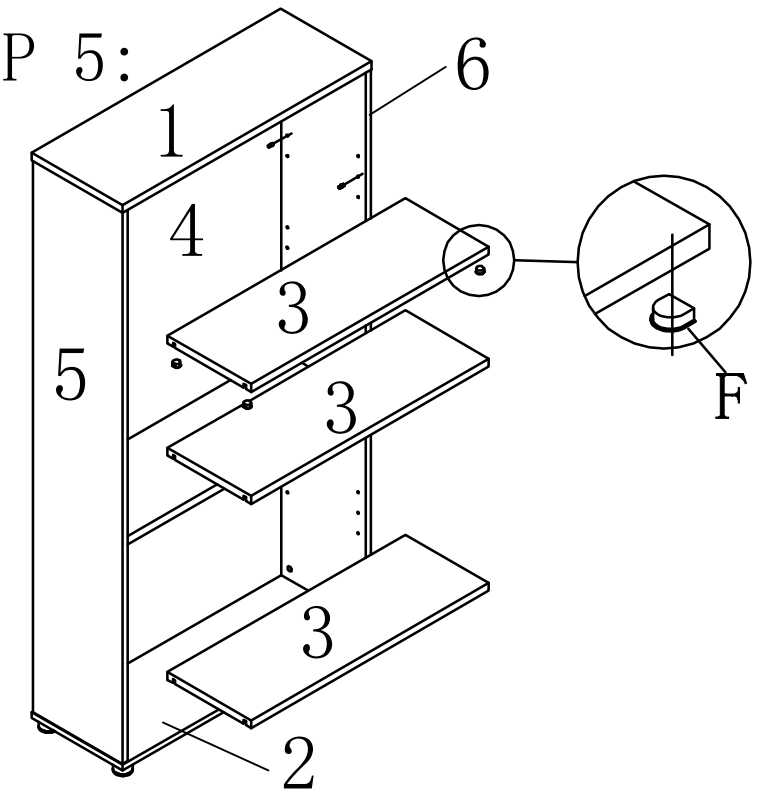

A

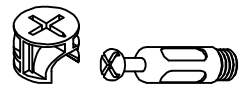

Pin + cam
X 15pcs

B

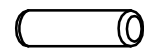

Dowel
X 9pcs

C



sticker
X 15pcs

D

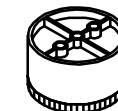

cabinet feet
X 5pcs

E



tapping screw
X 16pcs

F



shelf support
X 9pcs

G



Screw Driver
Not supplied