

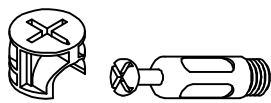
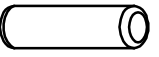
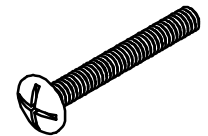

A  Pin + cam  
X 5pcs

WON-R96 900\*600\*730

B  Dowel  
X 4pcs

C  sticker  
X 10pcs

D  Bolt  
X 2pcs

E  Threaded insert  
X 2pcs

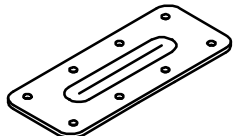
F  connection strap  
X 2pcs

G  tapping screw  
X 17pcs

H  tapping screw  
X 3pcs

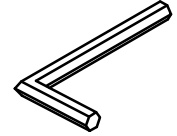
I  Allen Key  
X 1pcs

J  Screw Driver  
Not Supplied

STEP 1:

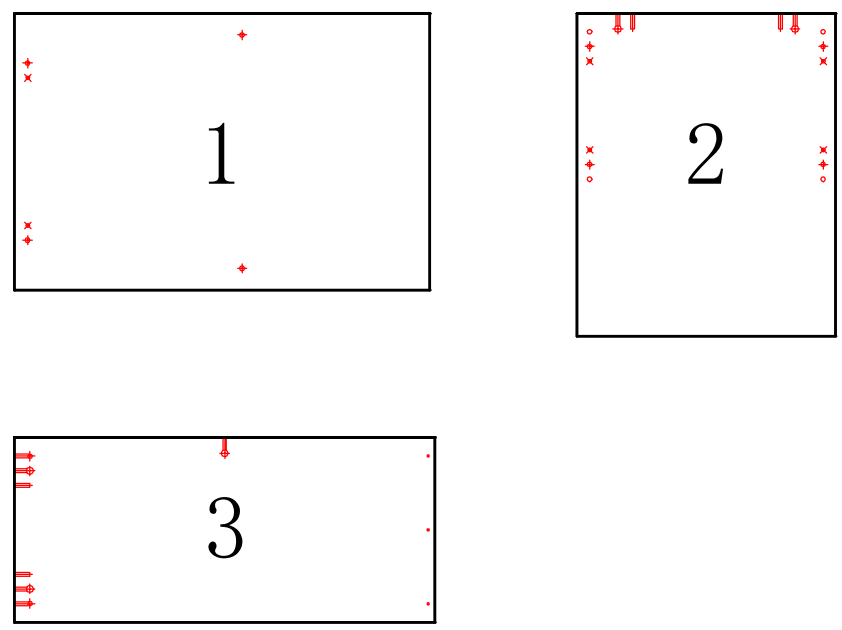

STEP 2:

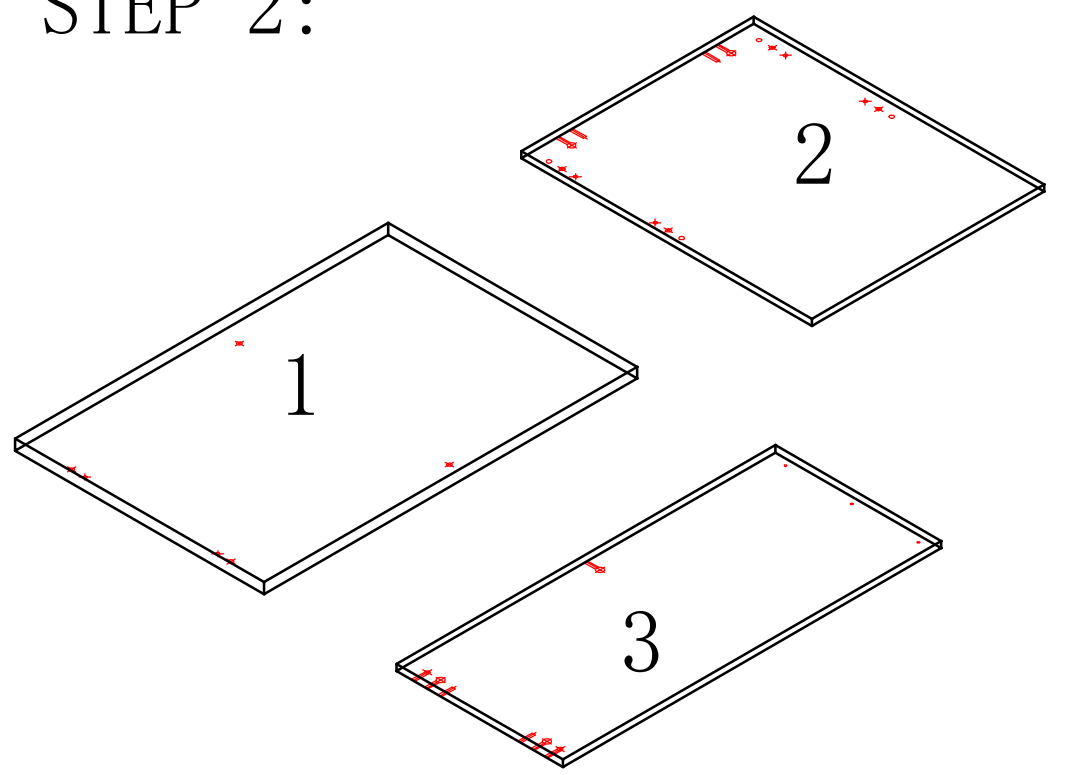

STEP 3:

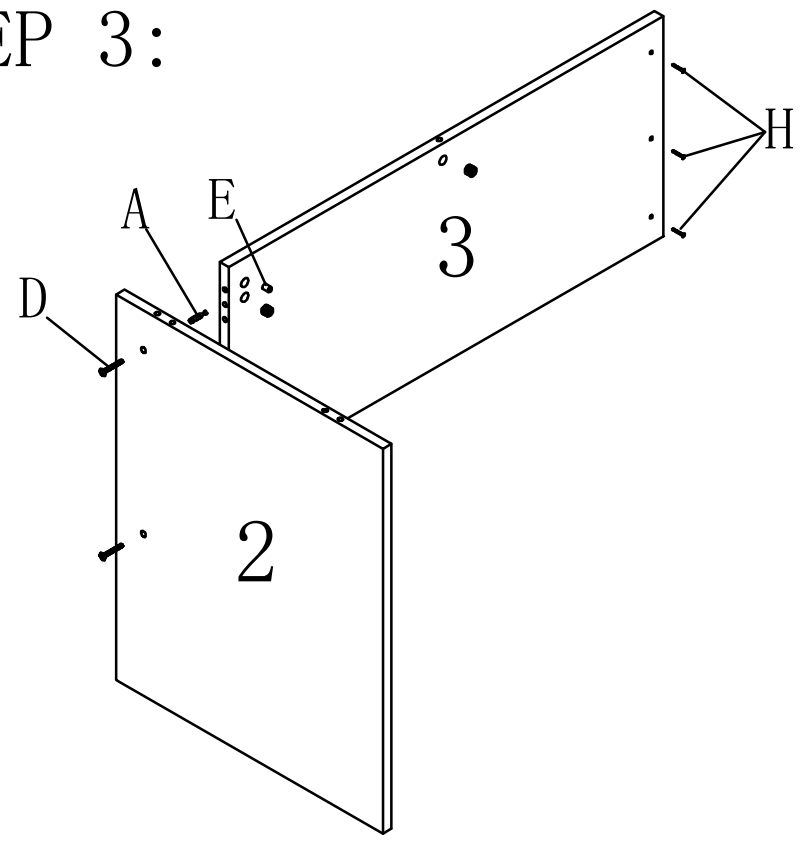

STEP 4:

